

Triple phase leg
Trench IGBT[®] Power Module

V_{CES} = 1700V
I_C = 50A @ T_c = 80°C

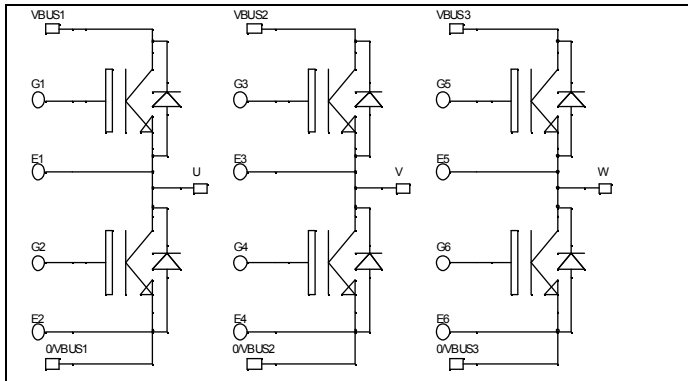

Application

- Welding converters
- Switched Mode Power Supplies
- Uninterruptible Power Supplies
- Motor control

Features

- Trench + Field Stop IGBT[®] Technology
 - Low voltage drop
 - Low tail current
 - Switching frequency up to 20 kHz
 - Soft recovery parallel diodes
 - Low diode VF
 - Low leakage current
 - Avalanche energy rated
 - RBSOA and SCSOA rated
- Kelvin emitter for easy drive
- Very low stray inductance
 - Symmetrical design
 - Lead frames for power connections
- High level of integration
- Kelvin emitter for easy drive

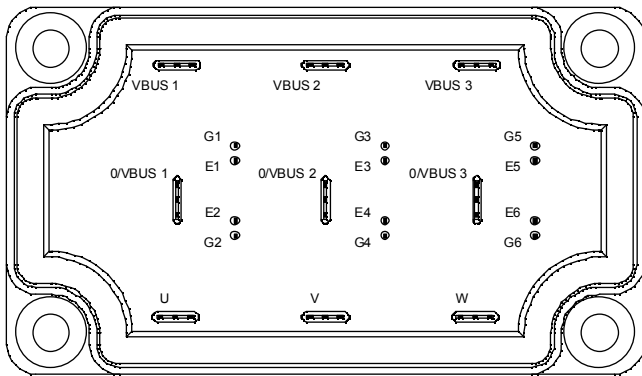

Benefits

- Stable temperature behavior
- Very rugged
- Solderable terminals for easy PCB mounting
- Direct mounting to heatsink (isolated package)
- Low junction to case thermal resistance
- Easy paralleling due to positive TC of V_{CEsat}
- Very low (12mm) profile
- Each leg can be easily paralleled to achieve a phase leg of three times the current capability
- Module can be configured as a three phase bridge
- Module can be configured as a boost followed by a full bridge

Absolute maximum ratings

Symbol	Parameter	Max ratings	Unit
V _{CES}	Collector - Emitter Breakdown Voltage	1700	V
I _C	Continuous Collector Current	T _C = 25°C	70
		T _C = 80°C	50
I _{CM}	Pulsed Collector Current	T _C = 25°C	100
V _{GE}	Gate - Emitter Voltage	±20	V
P _D	Maximum Power Dissipation	T _C = 25°C	310
RBSOA	Reverse Bias Safe Operating Area	T _J = 125°C	100A @ 1600V

 **CAUTION:** These Devices are sensitive to Electrostatic Discharge. Proper Handling Procedures Should Be Followed

All ratings @ $T_j = 25^\circ\text{C}$ unless otherwise specified

Electrical Characteristics

Symbol	Characteristic	Test Conditions	Min	Typ	Max	Unit
BV_{CES}	Collector - Emitter Breakdown Voltage	$V_{GE} = 0\text{V}, I_C = 2.5\text{mA}$	1700			V
I_{CES}	Zero Gate Voltage Collector Current	$V_{GE} = 0\text{V}, V_{CE} = 1700\text{V}$			5	mA
$V_{CE(on)}$	Collector Emitter on Voltage	$V_{GE} = 15\text{V}$ $I_C = 50\text{A}$		$T_j = 25^\circ\text{C}$ 2.0 $T_j = 125^\circ\text{C}$ 2.4	2.4	V
$V_{GE(th)}$	Gate Threshold Voltage	$V_{GE} = V_{CE}, I_C = 2.5\text{mA}$	5.0		6.5	V
I_{GES}	Gate - Emitter Leakage Current	$V_{GE} = 20\text{V}, V_{CE} = 0\text{V}$			600	nA

Dynamic Characteristics

Symbol	Characteristic	Test Conditions	Min	Typ	Max	Unit
C_{ies}	Input Capacitance	$V_{GE} = 0\text{V}; V_{CE} = 25\text{V}$		4400		pF
C_{rss}	Reverse Transfer Capacitance	$f = 1\text{MHz}$		150		
$T_{d(on)}$	Turn-on Delay Time	Inductive Switching (25°C) $V_{GE} = \pm 15\text{V}$ $V_{Bus} = 900\text{V}$ $I_C = 50\text{A}$ $R_G = 22\Omega$		200		ns
T_r	Rise Time			90		
$T_{d(off)}$	Turn-off Delay Time			720		
T_f	Fall Time			90		
$T_{d(on)}$	Turn-on Delay Time	Inductive Switching (125°C) $V_{GE} = \pm 15\text{V}$ $V_{Bus} = 900\text{V}$ $I_C = 50\text{A}$ $R_G = 22\Omega$		220		ns
T_r	Rise Time			90		
$T_{d(off)}$	Turn-off Delay Time			820		
T_f	Fall Time			110		
E_{on}	Turn-on Switching Energy ❶	Diode		29		mJ
E_{off}	Turn-off Switching Energy ❷			22		

❶ E_{on} includes diode reverse recovery

❷ In accordance with JEDEC standard JESD24-1

Reverse diode ratings and characteristics

Symbol	Characteristic	Test Conditions	Min	Typ	Max	Unit
V_{RRM}	Maximum Peak Repetitive Reverse Voltage		1700			V
I_{RM}	Maximum Reverse Leakage Current	$V_R = 1700\text{V}$	$T_j = 25^\circ\text{C}$		250	μA
			$T_j = 125^\circ\text{C}$		500	
V_F	Diode Forward Voltage	$I_F = 50\text{A}$ $V_{GE} = 0\text{V}$	$T_j = 25^\circ\text{C}$	1.8	2.2	V
			$T_j = 125^\circ\text{C}$	1.9		
Q_{rr}	Reverse Recovery Charge	$I_F = 50\text{A}$ $V_R = 900\text{V}$ $di/dt = 990\text{A}/\mu\text{s}$	$T_j = 25^\circ\text{C}$	19		μC
			$T_j = 125^\circ\text{C}$	30		

Thermal and package characteristics

Symbol	Characteristic	Min	Typ	Max	Unit	
R _{thJC}	Junction to Case	IGBT		0.4	°C/W	
		Diode		0.7		
V _{ISOL}	RMS Isolation Voltage, any terminal to case t=1 min, I _{isol} <1mA, 50/60Hz	3500			V	
T _J	Operating junction temperature range	-40		150	°C	
T _{STG}	Storage Temperature Range	-40		125		
T _C	Operating Case Temperature	-40		100		
Torque	Mounting torque	To heatsink	M6	3	5	N.m
Wt	Package Weight				250	g

Package outline

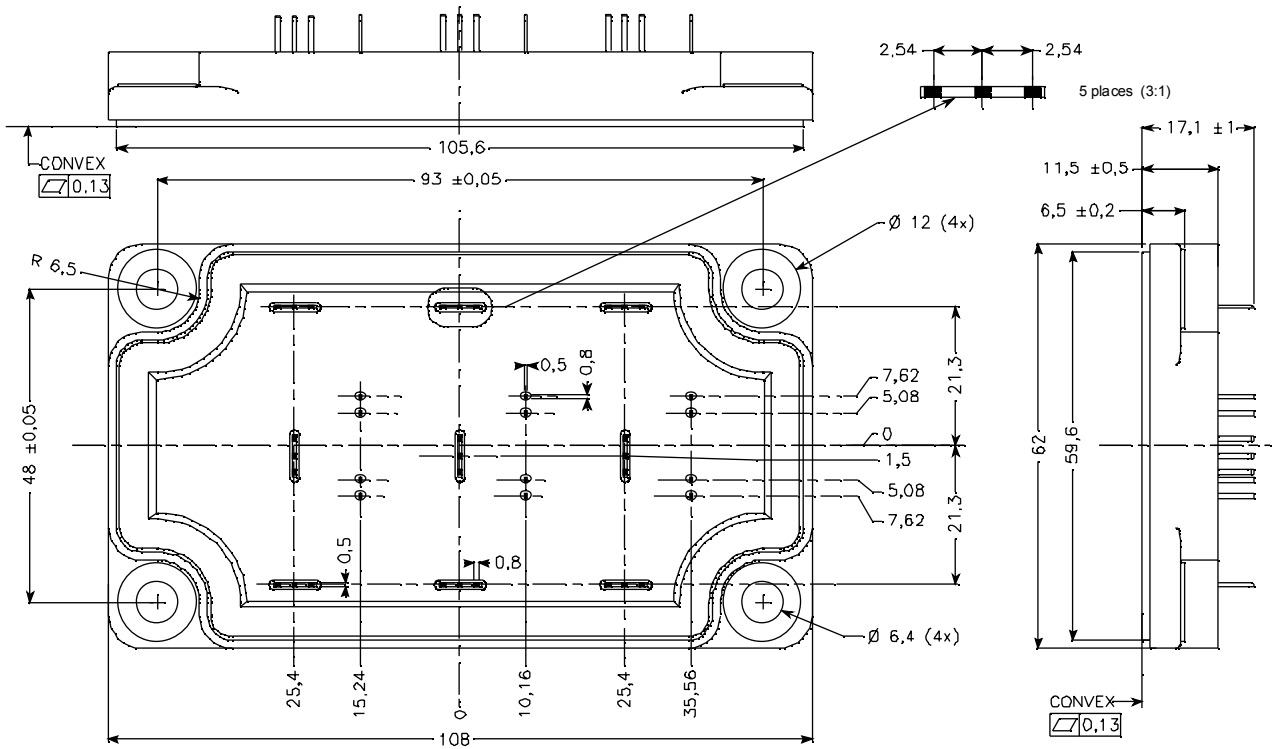

Typical Performance Curve

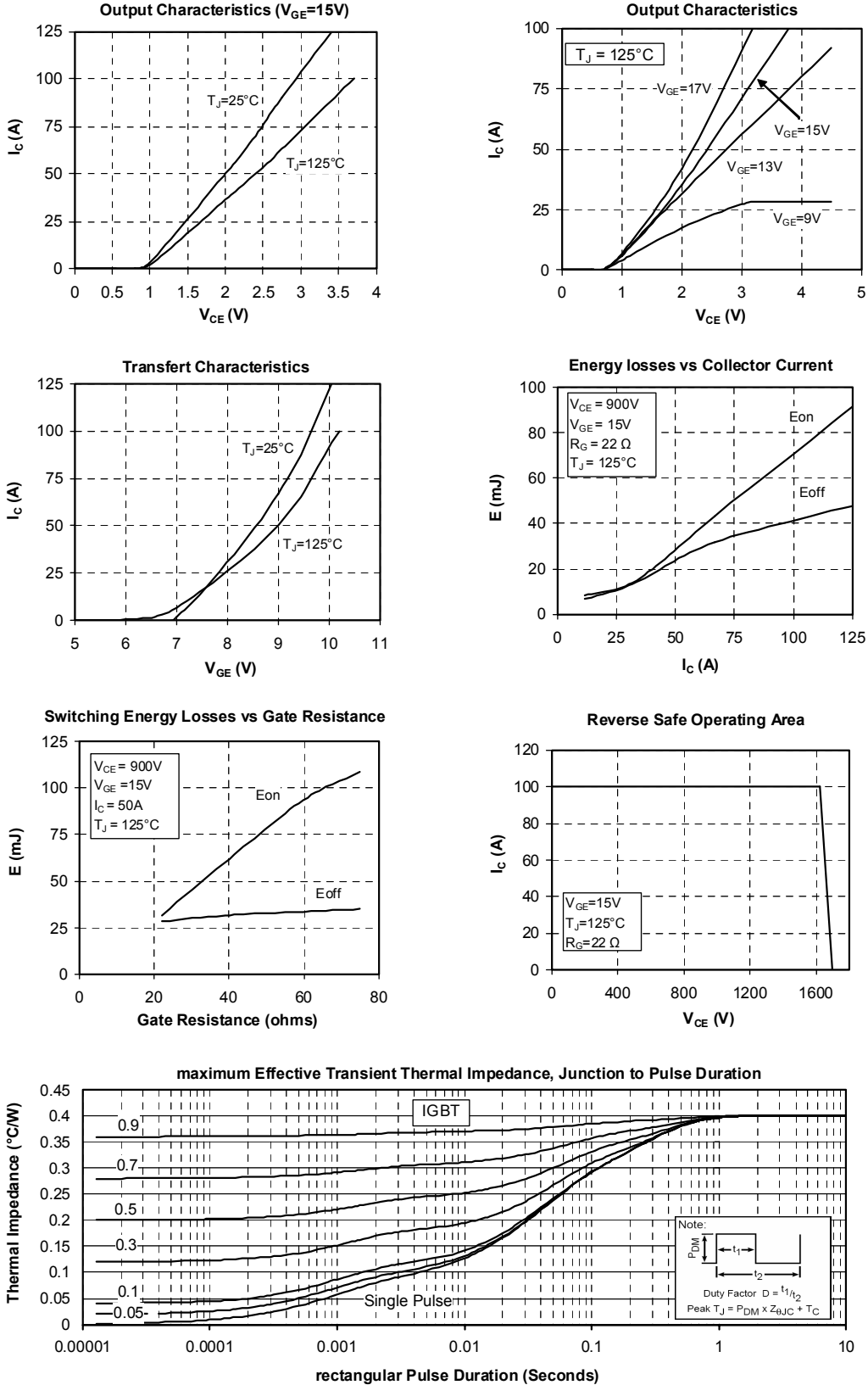

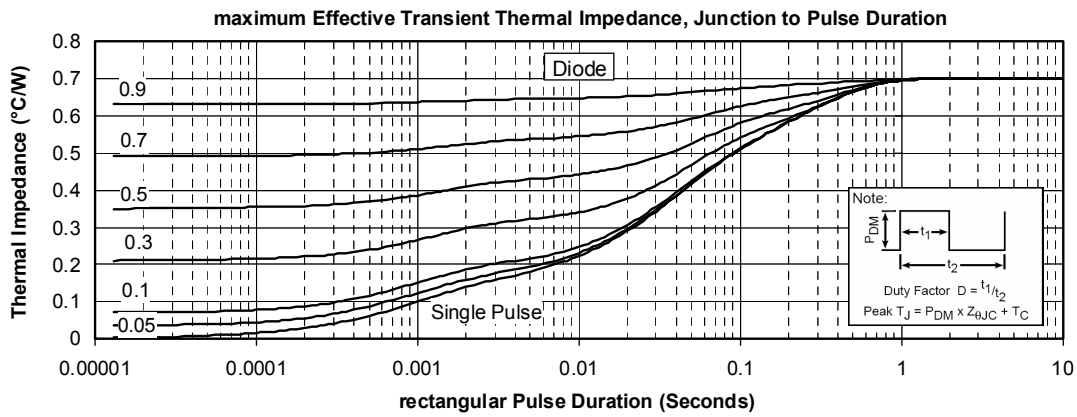
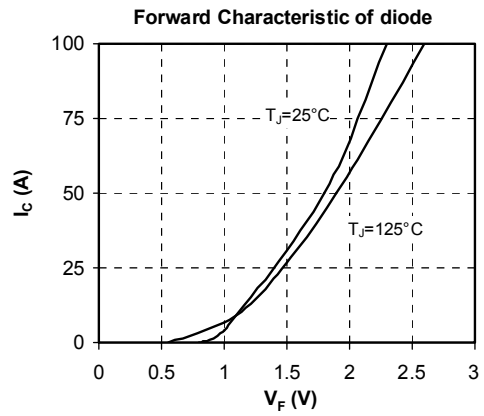
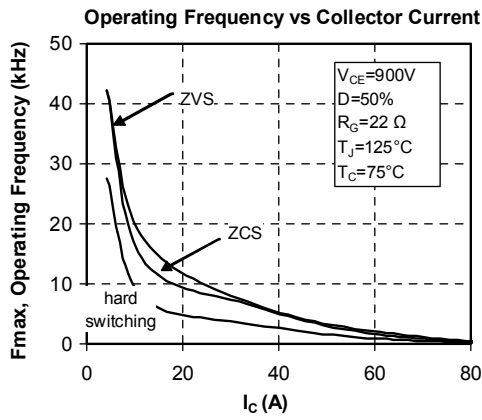

APT reserves the right to change, without notice, the specifications and information contained herein

APT's products are covered by one or more of U.S. patents 4,895,810 5,045,903 5,089,434 5,182,234 5,019,522 5,262,336 6,503,786 5,256,583 4,748,103 5,283,202 5,231,474 5,434,095 5,528,058 and foreign patents. U.S and Foreign patents pending. All Rights Reserved.